

C500

RO COMERCIAL 500

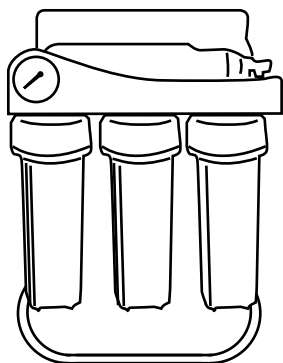

User's Manual

Reverse
osmosis equipment











C500

RO COMERCIAL 500

INDEX

1. USER MANUAL	5
2. TECHNICAL MANUAL	10
3. SANITIZING PROCEDURE	16
4. DATA SHEET	20

1. MAIN SPECIFICATIONS

 <p>CLICK Quick connectors and maximum safety</p>	●	 <p>SOLENOID VALVE Immediate control. Built-in safety mesh.</p>	●
 <p>MIXING VALVE System designed to adjust residual conductivity</p>	●	 <p>DIRECT FLOW Direct production of osmosis water without storage tank</p>	●
 <p>DIRECT ACCESS Easy maintenance</p>	●	 <p>HIGH PERFORMANCE MOTOR High performance motor</p>	●
 <p>ELECTRONIC ADAPTER Higher safety and efficiency</p>	●	 <p>HIGH EFFICIENCY High efficiency and recovery in production</p>	●
 <p>MANOMETER Pressure gauge</p>	●	 <p>FLUSHING MANUAL Manual membrane flushing</p>	●

THE EQUIPMENT FEATURES THE OPTION MARKED WITH ●

TECHNICAL MANUAL

500 Commercial RO

1. INTRODUCTION

Congratulations. You have purchased an excellent household water treatment equipment.

This equipment will help you improve the quality of the water in your home.

2. WHAT IS OSMOSIS?

Natural or direct osmosis is the most common in nature, since most of the organisms contain semi-permeable membranes (for instance, plant roots, organs in our body, cellular membranes, etc.).

When two solutions with different concentrations of salts are separated by a semi-permeable membrane, water flows naturally from the solution with a lower concentration of salts to that with a higher concentration. This flow continues until concentrations on both sides of the membrane are equal.

If this process was to be reversed in order to obtain water with a low salt concentration using a highly concentrated one, it would be necessary that highly concentrated water applies sufficient pressure against the membrane, in order to stop this tendency and the natural flow of the system. This process is called reverse osmosis. At present, reverse osmosis is the best method to produce pure water via a physical system (without using chemical products).

Water to be treated exerts pressure on the semi-permeable membrane, to the extent that part of it is able to pass through the pores of the membrane (osmosis water), while the remaining water (rejected water or that with high concentrations of salts) is diverted to the drainpipe (Fig. 1).

Fig. 1

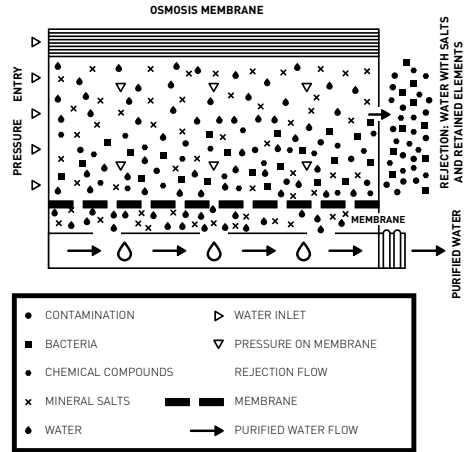

3. PRIOR WARNINGS

! *Warning: Carefully read all warnings included in the corresponding section of the Technical Manual.*

! *Warning: This equipment IS NOT A WATER PURIFIER. In the event of the water to be treated coming from a public water supply (and therefore meeting current legislation requirements), this equipment will substantially improve the water quality.*

Water treatment appliances need to undergo regular maintenance, which must be carried out by qualified technical personnel, with the aim of guaranteeing the quality of produced and supplied water.

3.1. USE OF THE EQUIPMENT

Should you be away from home for more than a week, close the water inlet, empty the system and unplug from the power supply (PUMP model). On your return, connect the power supply, and open the inlet valve and the tap. Let water flow for at least 5 minutes before consuming water.

! *Warning: After a prolonged period (more than a month) during which the system has not been in operation or produced water, contact your distributor in order to carry out proper hygiene and maintenance.*

To improve the performance of the equipment, extract full jugs and bottle sizes, and avoid the occasional extraction of a glass size.

! *Warning: Special attention must be paid to the regular cleaning and hygiene of the osmosis tap, especially during regular maintenance and hygiene. For this purpose, use the Oxibac spray and disposable kitchen paper towels. Under no circumstances must a hand towel or a multi-use cloth for the kitchen be used.*

3.2. RECOMMENDATIONS ON HOW TO PROPERLY USE REVERSE OSMOSIS WATER

If you wish to feed any other consumption point with osmosis water (such as a fridge with an ice-cube dispenser, another tap, etc.), the piping should not be done with a metal tube, as this would give water a bad taste. Always use a plastic tube.

! *Warning: Water supplied by household osmosis equipment has a LOW MINERAL CONTENT. The mineral salts required by the human body are provided by food, especially by dairy products and to a lesser degree, by the water we drink.*

It is recommended not to use aluminium utensils for cooking with reverse osmosis water.

- This equipment has a built-in mixing valve. The user will be able to regulate the salinity of supplied water to the desired taste and/or local regulations. This regulation must be carried out while the equipment is producing water.

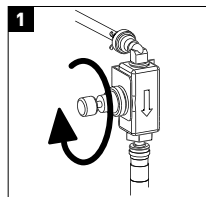

To make the mixing system work, extract full jars. In function of the model, the mixing valve can be found in different places.

4. BASIC OPERATION

Tap water to be treated enters the system going through the sediment and the carbon filter. During this filtering stage, chlorine, its derivatives and other organic substance particles are retained.

The flow of water towards the system is controlled by an electrovalve.

After the water passes through the filtering stage, it is fed to the reverse osmosis membranes. The equipment includes a pump to increase the pressure, since water pressure on the membrane makes the reverse osmosis process possible.

Osmosis water from the equipment can be consumed through the tap. Water that is rejected or has excessive salt or other dissolved substances is fed towards the drain outlet to be disposed of.

When the tap is closed, a high pressure switch stops the equipment.

This equipment has a low pressure switch as a safety system, which protects the pump against pressure drops by stopping the equipment and preventing a vacuum operation.

5. USER INTERFACE

! *Warning: This equipment includes an electronic controller which will efficiently manage functionality and status indications, as well as the different safety systems.*

The data sheet of the appliance describes the states which may be found in the equipment, as well as the information they supply.

6. MAINTENANCE

With the aim of guaranteeing the quality of the water supplied by your equipment, it should undergo regular maintenance.

Read the corresponding section of the Technical Manual to check the recommended maintenance frequency.

7. TROUBLESHOOTING

SYMPTOM	CAUSE	SOLUTION
1. Leak outside the system	Multiple causes	Call the Technical Service
2. No production.	There is no water supply	Wait until water supply is re-established
	There is no power supply	Check the power supply of the house. If the problem persists, please call the Technical Service.
3. Low production	Inlet valve is partially closed	Open it
4. Excessive production	Multiple causes	Call the Technical Service
5. Unpleasant taste and odour.	Multiple causes	Call the Technical Service
6. Water has a white colour.	Air bubbles inside the system. These micro-bubbles will disappear after a few seconds	This is not a problem. This appearance of the water will slowly disappear as the air inside the system is removed.
7. Rejection does not stop.	Multiple causes	Call the Technical Service
8. The equipment does not start	There is no water supply	Check the state of the main inlet valve of the house and the appliance
	There is no power supply	Check the general power supply. If the problem persists, please call the Technical Service.
9. System turns constantly on and off	Multiple causes	Call the Technical Service
10. The equipment is always rejecting water to the drain	Inlet electrovalve is worn	Check and replace
	Production check valve is worn	Check and replace

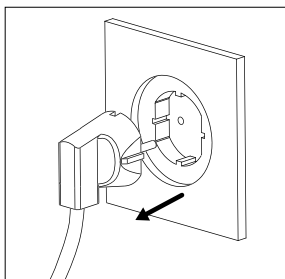
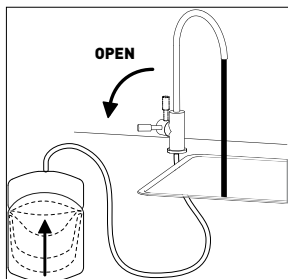
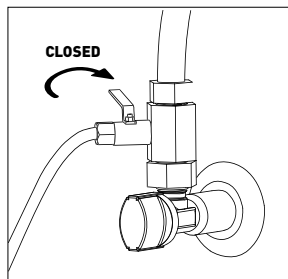

In the event of a fault, contact the Technical Assistance Service and proceed as follows: Close the inlet valve. Open the tap to depressurise the system and unplug it.

* This feature depends on the model. Further information in the *Data Sheet*.

TECHNICAL MANUAL

500 Commercial RO

1. TECHNICAL CHARACTERISTICS

Application	
Water treatment	• Reverse osmosis
Use	• Improves the drinking water's characteristics (meeting all European Directive on Water for Human Consumption 98/83 requirements and its national transpositions in the various EU member states).

Modifications due to reduction or contribution	• Water treatment via reverse osmosis is able to greatly reduce salt and other concentrations. Minimum reduction* of specific compounds and parameters: Sodium Calcium Sulphates Chloride Total Hardness Conductivity In function of the characteristics of the water to be treated (in the membrane outlet). These values may vary in function of the type of post-filter used by the equipment and/or setting of the mixing valve (where applicable).
--	--

Working limits	
Pressure (max. / min.)	5 bar (600 kPa) 1 bar (100 kPa)
TDS (max.)	1500 ppm
Temperature (max. / min.)	40°C – 2°C
Hardness (max.)	15°HF**

! (*) For salinity levels above 1500 ppm, please check with your distributor.
! (**) for maximum performance and longevity of components.

! Warning: in the event of any queries in relation to installation, use or maintenance of this equipment, please contact your distributor's Technical Assistance Service (S.A.T).

2. PRIOR WARNINGS

! Warning: This equipment IS NOT A WATER PURIFIER. In the event of the water to be treated coming from a public water supply (and therefore meeting current legislation requirements), this equipment will substantially improve the water quality.

! Warning: In the event of the water to be treated not coming from a public water supply or from an unknown source, a physico-chemical and bacteria analysis of the water to be treated should be completed in order to ensure the correct purification process, by applying the appropriate techniques and equipment as necessary PRIOR TO THE INSTALLATION of the equipment. Please contact your distributor in order to receive advice on appropriate treatment.

2.1 CONDITIONS FOR THE CORRECT WORKING OF EQUIPMENT

- The equipment should not be used with hot water ($T > 40^{\circ}\text{C}$).
- The room temperature must be between 4° and 45°C .
- For water with a salinity higher than 1500 ppm contact your distributor.
- We recommend that the water to be treated should be softened or with a maximum hardness level of 15°HF in order for your equipment to achieve maximum performance.
- In the event of the water to be treated having a hardness level in excess of 15°HF , the equipment's membrane life and equipment performance may be affected.
- Should the water from the supply network contain a concentration of total chlorine higher than 1.2 ppm, it is recommended to install an activated carbon chlorine removal filter, in order to reduce the chlorine concentration in water, as well as protecting and extending the service life of the system's components.

In the event of the water to be treated containing:

- High concentrations of iron and manganese (In excess of 1ppm measured in the machine's rejection process).
- Prolonged hyper-chlorination.
- Sludge or turbidity in excess of 3 NTUs.
- A nitrate concentration in excess of 100 ppm.
- A sulphate concentration in excess of 250 ppm.
- Please consult your distributor for an appropriate pre-treatment recommendation, as well as ensuring the correct working of your equipment, avoiding any damage to components and to ensure the quality of the water supplied.

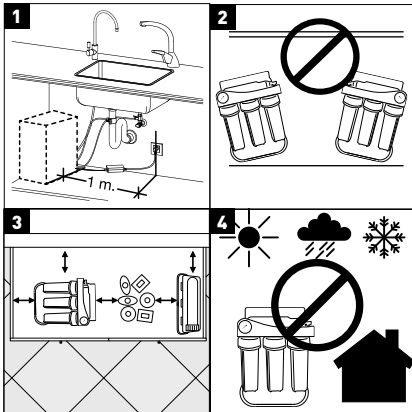

3. EQUIPMENT INSTALLATION

- In the event of modifying the home/workplace in order to install the equipment in the planned location, it should be done following national guidelines for interior installations of water and electric supply.
- Equipment of the 500 COMMERCIAL RO series requires an electric outlet distanced at least 1 metre (1).
- The equipment of the 500 COMMERCIAL RO series should not be installed horizontally or at an angle (2), which would render the leak sensor useless.

The equipment when full with water weighs more. Unexpected weight distribution may cause a connection element to become strained thus causing incorrect working of the machine, damaging components or causing a loss of water.

- The installation location should have sufficient space for the machine itself, its accessories, connections and room for servicing and repair (3).

Under no circumstances should the equipment be installed outdoors (4).

- The environment where the equipment and tap are to be installed should adhere to any appropriate hygiene and sanitation conditions.
- Avoid any external dripping liquids from pipes or wastewater etc. onto the equipment.

! **Warning:** The equipment should not be installed next to a heat source or in the face of direct hot air (hair dryer, refrigerator etc.).

3.1. INITIAL OPERATION AND MAINTENANCE

! **Warning:** Water treatment appliances need to undergo regular maintenance, which must be carried out by qualified technical personnel, with the aim of guaranteeing the quality of produced and supplied water.

- Replaceable parts should be replaced as advised by the manufacturer.
- The equipment should be sanitised periodically and prior to its initial operation.
- After initial operation, the water produced during the first 5 minutes should not be consumed.
- Maintenance should be carried out by qualified technicians who work under the appropriate hygienic conditions in order to reduce the risk of internal contamination of the equipment and its hydraulic system. For further information contact the technical service of your distributor.
- The mixing valve should always be closed during installation and initial operation. The mix should be set to the required characteristics and in accordance with the corresponding national legislation (measuring with an independent device / TDS/pH measure, on the tap dispenser section), while the equipment is filtering.

4. UNPACKING

Before installation and initial operation it is important to check the contents of the box and the condition of the equipment in order to check it has not been damaged during transport.

! *Warning: Claims due to damage in transit should be submitted along with the distributor delivery sheet or invoice, including the name of the freight company within 24 hours after reception of the goods.*

Unpack the equipment and its accessories from its packaging and dispose of any protective packaging material.

! *Warning: Dispose of and keep plastic bags out of the reach of children, as they may be dangerous.*

Inside you will find: Water treatment equipment, installation accessories and documentation.

Recyclable materials have been used for the packaging and should be disposed of in the appropriate recycling bins or at the specific local waste product recycling centre.

This product cannot be disposed of with other domestic waste products. At the end of the product's useful life, the equipment should be returned to the place of purchase, or at a local recycling centre, indicating that said equipment contains electric and electronic components. The correct collection and treatment of products, which no longer are to be used, contributes to the preservation of natural resources and avoids any potential public health risks.



5. INSTALLATION

The installation of your osmosis equipment should be carried out by a suitably qualified technician. Please read carefully the user manual before use and consult with your distributor in case of doubt.

! *Warning: Given that the equipment to be installed will improve the quality of your drinking water, all tools to be used in the installation process should be clean, rust and grease free. Only use tools, which are specifically designed for membrane tube cutting. Please keep tools clean and disinfect them periodically.*

! *Warning: The installation process should be carried out under appropriate hygienic conditions, taking all necessary precautions in relation to materials and components that will come into contact with water to be treated or consumed.*

(For further information, please contact your distributor).

! *Warning: Avoid external contamination of the equipment through improper handling, using gloves, sanitising gel and washing hands as often as is necessary during the installation process, initial operation and equipment maintenance.*

The most common installation location tends to be under the kitchen sink unit or in an annexed fitting.

Install the tap, the waste water clamp and entry inlet adapter and connect the equipment's respective connectors (5, 6 and 7).

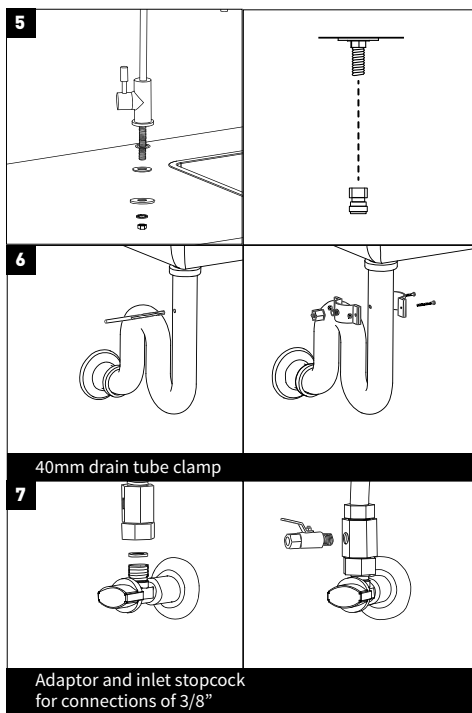

! *Warning: Some of the installation accessories may vary in function of the model and distribution region.*

6. INITIAL OPERATION

6.1 SEDIMENT & CARBON FILTER RINSING

The elimination of carbon dust caused by the filter during transport and handling of the equipment is required. This dust should be eliminated as it may completely or partly obstruct the reverse osmosis membrane as well as causing the equipment to malfunction.

To complete this process, disconnect the tube before the membrane housing inlet. Power the equipment hydraulically and electrically, and run this tube towards an external recipient or sink until the water runs clear.

! *Warning: Do not clean the carbon pre-filter with the tap, as the carbon to be removed will penetrate the equipment's components causing malfunction and/or reducing the useful life of certain components.*

After washing the filters, leave all tubes and components in their original position and connection points.

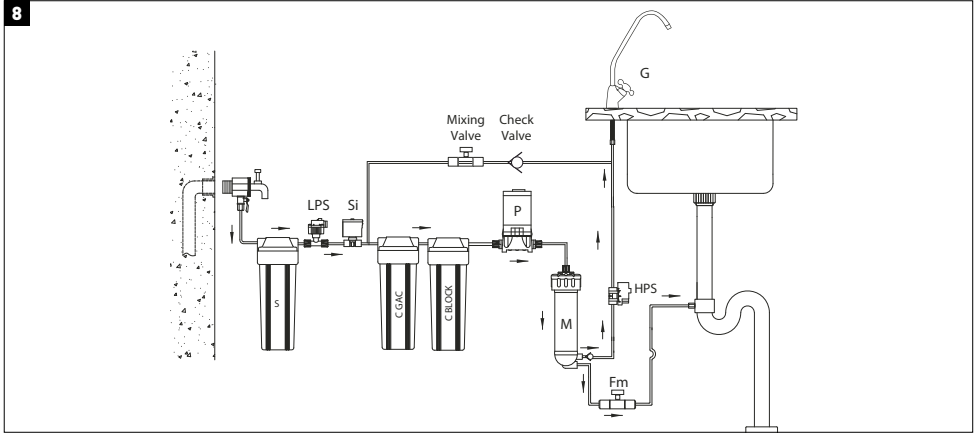

6.2. MEMBRANE ASSEMBLY

! *Warning: Take stringent hygiene measures when handling the membrane.*

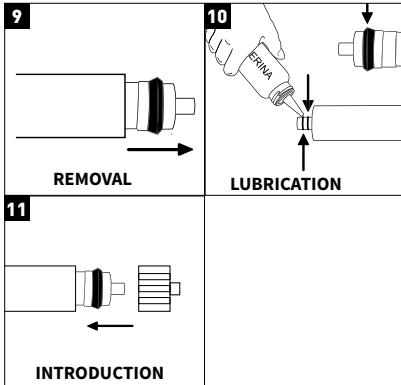

Insert the membrane into the membrane housing paying close attention to placing it the right way in the container and using a food grade lubricant for connecting parts in order to avoid clamping during installation.

! *Warning: If during the membrane housing handling there is any movement from the connecting screws they should be dismantled, "tefloned" and sealed again after membrane installation in order to reduce future leakage risks.*

6.3. SANITIZE THE EQUIPMENT

Sanitize the equipment according to the model and procedure indicated by the manufacturer (see *Sanitizing Procedure*). In the event of any queries please consult with your distributor.

6.4. SYSTEM STOP, START AND WATERTIGHT CHECK

Turn off the equipment's tap on the work surface with the hydraulic and electric power on, and carry out a visual inspection of the equipment ensuring no leakages occur (during approx. 1 minute).

In the event of the pump failing to stop, adjust the maximum pressure gauge setting with a 2mm Allen key until the pump stops (12).

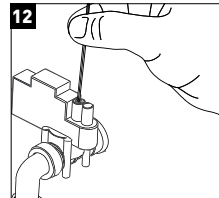

Open the water supply tap. The equipment should turn on and supply water.

Close the tap again and check that the equipment stops.

6.5. RINSING AND CLEANING

Turn on the equipment's tap and check the quality of the water being dispensed with a conductivity tester or TDS; check the reduction of salt obtained is sufficient in relation to the water to be treated (13).

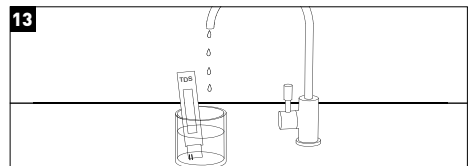

! *Warning: In the event of discovering that the water dispensed does not adhere to current national legislation, make sure that the mixing valve is closed and repeat the measurement. If the deviation persists, close the inlet valve of the equipment, empty it with the tap, disconnect it from the electric mains and contact your technical service facility.*

Finally, clean the interior and the bottom of the equipment with single use drying paper in order to remove any water, which may have been left, since it could cause a false alarm, which would block the system.

7. MAINTENANCE

! *Warning: Some of your equipment's components, such as the pre-filter and the membrane are consumable items which have limited lifetime.*

Their duration will depend on the quality of the local water, consumption, type of use and specific water conditions such as extreme turbidity, high chlorine levels, excessive iron content etc.

! *Warning: With the aim of guaranteeing the quality of the water supplied by your equipment, it should undergo regular maintenance.*

Recommended maintenance
<ul style="list-style-type: none"> • Filters: At least once a year *
<ul style="list-style-type: none"> • Osmosis membrane: Every 3 years approx. (for soft water - hardness <15°HF)
<ul style="list-style-type: none"> • Sanitization: During initial operation. At least once a year in function of the use. Each time components in contact with water are accessed or water has not been consumed for more than a month.

* In function of the characteristics of the water and its use.

All maintenance should be carried out by qualified technicians who should handle the equipment properly, as well as using original replacement parts in order to maintain the equipment's characteristics, warranty, equipment features as well as preserving the quality of the water dispensed.

! *Warning: The use of non-original replacement parts, non-regulatory installation or initial operation, maintenance or improper use may invalidate the warranty, as well as rendering invalid the equipment's certifications.*

An excess of any compound (total chlorine, turbidity, hardness etc.) may reduce the equipment's useful life and certain components. This maintenance advice is only a guide.

Your distributor will estimate the life of the replacement parts in function of the characteristics of the water to be treated as well as the expected consumption in each case.

! *Warning: All replacement parts come in specially designed individual packaging to ensure hygienic storage and transit. Take special hygiene measures when removing said parts from their packaging as well as during*

handling of the various components and connectors.

! *Warning: Before dismantling the equipment, make a note of all material necessary for the required maintenance (read section 5 installation) as well as the necessary space for work. Work should be carried out in a correctly lit place, in appropriate hygienic conditions and with sufficient space to work comfortably.*

Change the filters properly. Ensure unions are watertight and the original hydraulic settings as recommended by the manufacturer.

Sanitize the equipment following the instructions in the Sanitizing Procedure.

For further information consult the equipment's Technical Sheet. In the event of any doubt please contact your distributor.

In the event of replacing the membrane, follow the manufacturer's instructions in relation to handling and sanitizing as appear in the Sanitizing Procedure.

! *Warning: Use gloves or appropriate personal protection measures when using chemical products during the sanitizing procedure.*

! *Warning: In the event of detecting that the water dispensed fails to adhere to current national legislation, close the equipment's inlet stopcock, empty via the tap, disconnect from the electricity mains (according to model) and contact your technical service facility.*

SANITIZING PROCEDURE

1. SANITIZING

Necessary materials:

- Manual valve.
- Measuring cup and connectors.
- Hydrogen peroxide (0.5 l).
- Brush.
- Disposable vinyl gloves.
- Easy-to-rinse soap or detergent.
- Food-grade lubricant.
- Strips to detect hydrogen peroxide.
- Sanitizing spray.
- Paper napkin.

The appliance must be sanitized when necessary during initial operation, (whenever there is a risk of contaminating the appliance due to the manipulation of components in contact with water) or within the indicated frequency. To do so, follow the instructions below:

! *Warning: Water used during the sanitizing process must be drinking water from the public network and comply with the corresponding drinking quality requirements from RD 140/2003, EU Directive 98/83 or the local regulations in force.*

1. Open the tap and let water recirculate to renew the water inside the equipment.
2. Close the inlet valve (1) and open the water supply tap (2) to reduce pressure in the equipment.

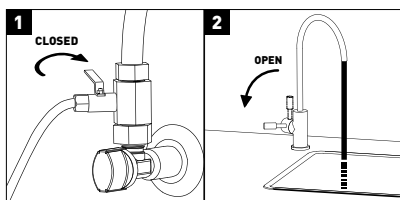

• Change and wash the filters, as outlined in the corresponding section of the *Technical Manual*. The sanitizing procedure must be carried out with new pre-filters and post-filters. Rinse the filters before starting the procedure (to properly remove carbon dust).

• Use disposable vinyl gloves (3) to handle sanitizing products.

! *Warning: Maintain a high standard of hygiene when handling the membranes and the components of the appliance in contact with water. Use disposable gloves or wash your hands as often as necessary to avoid risk of contamination in the appliance.*

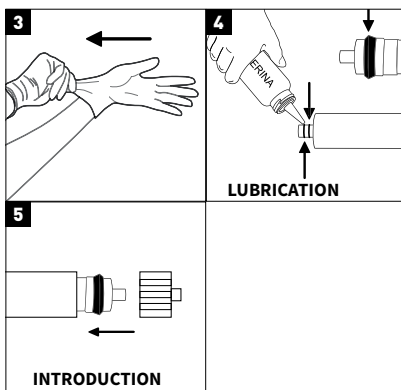

• To sanitize the appliance, the membrane must be inside the membrane housing.

If a new membrane must be installed: open the package, rinse it with tap water, lubricate the joints from the membrane with a food-grade lubricant (4 and 5) to prevent them from pinching during installation and insert it inside its housing in the proper direction.

Before opening the membrane housing, make sure you have a receptacle ready where you can partially empty it, as it might be full of water.

If you must replace an exhausted membrane for a new one: remove the exhausted membrane (6), throw it away and clean the inside of the membrane housing with a brush (it must be clean and disinfected) along with an easy-to-rinse (low foaming) soap or detergent, suitable for cleaning surfaces intended to be brought into contact with food (7). Then, rinse the membrane housing properly making sure that all traces of detergent are removed.

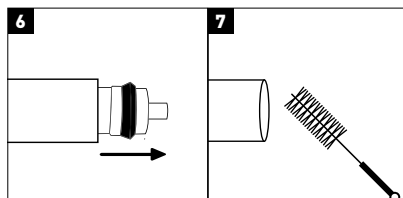

2. PRE-FILTER AND MEMBRANE TREATMENT

• Disconnect the inlet tube of the system marked as “feed-entrada” and place the dosage housing between the water inlet and the inlet of the appliance (8). For an easier and

more comfortable access during the sanitizing process and the opening and closing of the inlet valve, a manual valve in the closed position can be placed along with the sanitizing dosage housing. This valve will work as the manual inlet valve of the system.

- Once the set has been installed, keep the new manual inlet valve closed and open the inlet valve that is connected to the wall adaptor (9). The dosage housing must be empty.

- Pour 0.25 litres of hydrogen peroxide in the dosage housing placed at the appliance's inlet (10). Screw the housing properly in its head.

- The inlet manual valve and the tap must be closed. Plug the system to the power supply.

- Open the inlet valve and the tap, and let the appliance start working so it will absorb the hydrogen peroxide. Fill a 1 litre jug with tap water. Before closing the tap, close the inlet valve again to decrease pressure. Fill the dosage housing again with 0.25 litres of hydrogen peroxide and

empty another litre of water. Close the tap. Now the whole circuit is full of sanitizing liquid.

- After 10 min open the water supply tap (11) and let tap water flow during 5 min.

- Empty the dosage housing. Before opening this housing, make sure you have a receptacle in place where you can empty it since it might be full of water.

Pay special attention to the disinfection of the tap spout. Use a sanitizing spray (or hydrogen peroxide, by applying it in such a way that it goes inside the tap) and disposable kitchen paper towel. Apply the sanitizing spray on the tap nozzle (12), rub the spout and the nozzle with disposable paper towel and do not touch it with bare hands (13).

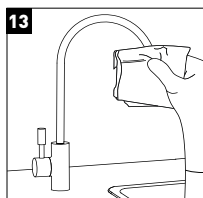
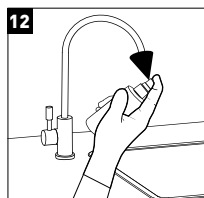
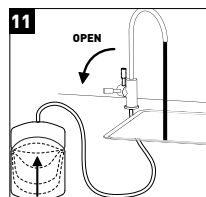
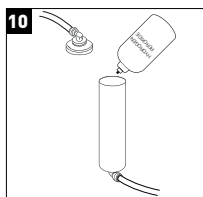
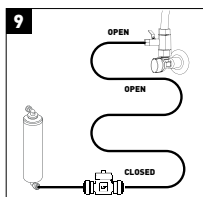
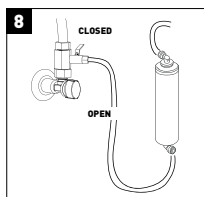

3. RINSING

- Rinse the osmosis equipment with plenty of water after each sanitizing procedure by letting tap water of an appropriate quality circulate for at least 5 minutes.
- Rinse the pre-filter after each replacement and before carrying out a sanitizing procedure in the equipment.
- It is preferable to rinse the pre-filter apart from the rest of the equipment, even before installing it.
- Rinsing must be made with plenty of water complying with local regulations concerning the drinking water quality requirements.
- Fill the pre-filter slowly to release trapped air and prevent internal turbulences which may alter the different filtering stages. When water starts coming out of the outlet, increase the flow gradually. Extract at least 4 litres and make sure that water no longer contains carbon dust.
- Keep the filter in the same position it will have after installation throughout the entire process.
- At the end, dry all the parts that may have got wet using a disposable paper towel, specially the Aquastop leakage sensor (if included in the appliance).
- Since sanitizing and rinsing do not either guarantee the complete removal of carbon dust found in new filters or sanitizing residues, the tank must be emptied twice before consuming produced water.

DATA SHEET

500 Commercial RO

1. TECHNICAL CHARACTERISTICS

Application	
Water treatment	• Reverse osmosis

Use	
	• Improves the drinking water's characteristics (meeting all European Directive on Water for Human Consumption 98/83 requirements and its national transpositions in the various EU member states).

Modifications due to reduction or contribution	
	• Water treatment via reverse osmosis is able to greatly reduce salt and other concentrations. Minimum reduction* of specific compounds and parameters: Sodium Calcium Sulphates Chloride Total Hardness Conductivity In function of the characteristics of the water to be treated (in the membrane outlet). These values may vary in function of the type of post-filter used by the equipment and/or setting of the mixing valve (where applicable).

Working limits	
Pressure (max. / min.)	6 bar (600 kPa) 3 bar (100 kPa)
TDS (max.)	1500 ppm
Temperature (max. / min.)	40°C – 2°C
Hardness (max.)	15°HF**

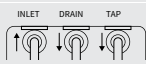
Technical Information	
Control type	High pressure switch. Entry control by-pass electrovalve.
Safety system	Low pressure switch.
Dimensions (mm) (A x B x C) Weight (kg)	470 x 360 x 210 12 
Total tank volume	-
Inlet connection	3/8"
Drain connection	1/4"
Tap connection	1/4"
Wall adapter	3/8" M-F *****
Drain clamp	40mm drain tube clamp 

Data Sheet

Pre-filters

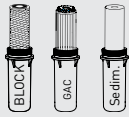

1 x Sediments 9 3/4"
 1 x GAC 9 3/4"
 1 x BLOCK 9 3/4"

Membrane

Production: 400 GPD

IN/INLET

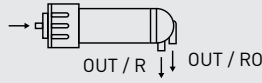

IN: RH 1/4"
 OUT: RO RH 1/4"
 OUT: R RH 1/4"

Power supply

36 Vdc 3 A

Power adapter

100-240 Vac 50/60 Hz: 36 Vdc

Production

1 lpm.
 Without counter pressure.
 Water to be treated 15 °HF.
 200 ppm, 14 °C, 2 bar****

Manual flushing

Hydraulic diagram

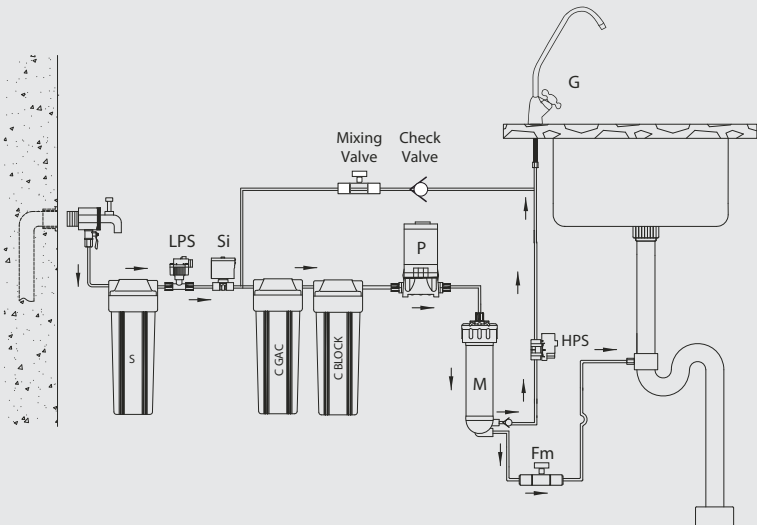

Electrical diagram

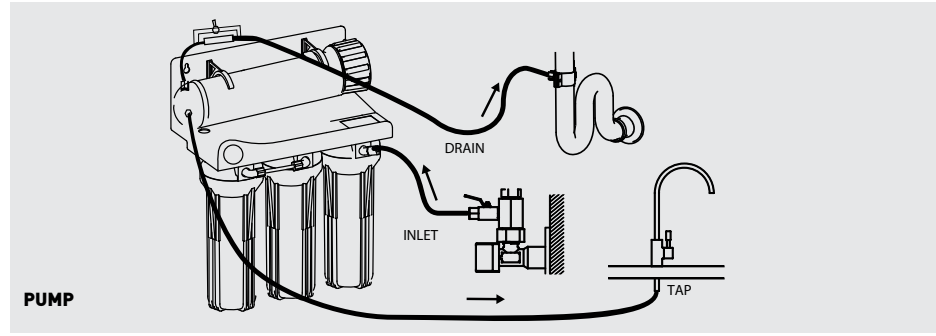
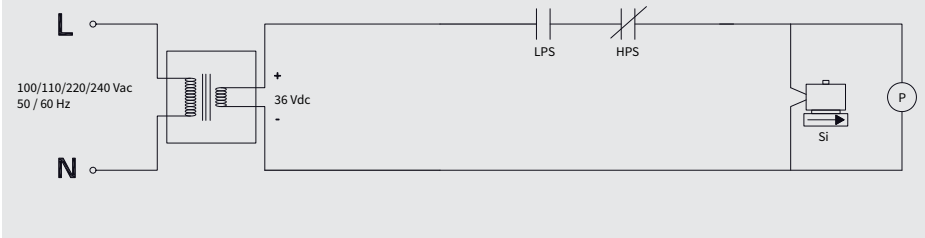

Hydraulic connections diagram

- * For salinity levels above 1500 ppm, please check with your distributor.
- ** Higher levels of hardness can reduce the service life and correct function of certain components.
- *** Maximum accumulation in function of entry pressure.
- **** Flows can vary by up to 20% in function of the temperature, pressure and specific composition of the water to be treated.
- ***** Possible variations in function of model chosen.

2. HOW THE EQUIPMENT WORKS

The mains water to be treated is fed to the equipment passing through the pre-filtering stage that incorporates a turbidity (S) and a carbon filter (C). During this filtering stage, chlorine, its derivatives and other organic substance particles are retained.

- The flow of water towards the system is controlled by an electrovalve (Si).
- After the water passes through the filtering stage, it is fed towards the reverse osmosis membrane (M). The equipment incorporates a pump (P) to increase pressure. It is the effect of the water pressure upon the membrane, which makes the reverse osmosis possible.
- Water that is rejected or has excessive salt or other dissolved substances is fed towards the drain outlet to be disposed of.
- Direct flow equipment controls the operation and the flow via a pressure switch (HPS).

3. INTERFACE. SYSTEM STATUS.

It does not incorporate an electronic interface. It includes a pressure gauge to control pressure.

DISTRIBUTED BY:
B-60326279
Made in China

Data Sheet

4. WARRANTY

END USER WARRANTY:

The distributor guarantees this equipment for a period of two years against any fault found, and in accordance with the provisions of RD (Royal Decree) 1/2007 of the 16th of November (Amended text of the General Law for the Protection of Consumers and Users). This guarantee encompasses repair and replacement of defective parts by personnel authorised by the distributor or by the Official Technical Assistance Service (SAT), either at the location of installation or at their respective workshops. Labour and shipping costs incurred by said repairs are included in the guarantee. IF/PEU/PAM will not be liable to honour the warranty in the event of parts, which are subject to general wear and tear, lack of due maintenance, damage or other incidents due to the consequence of misuse or inappropriate use in accordance with conditions, and functional limits of said equipment as indicated by the manufacturer. Furthermore, the warranty will be rendered invalid in the event of poor use or in the event of said equipment being modified or repaired by personnel not authorised by the distributor or by the official SAT. Replacement parts under warranty shall remain the property of IF/PEU/PAM. IF/PEU/PAM shall be held responsible for any lack of conformity of equipment in relation to its origin, identity or appropriateness of the products, in accordance with equipment type and end use. Taking into account the equipment's characteristics, in order for the warranty to cover any lack of conformity, the adherence to the installation and working technical conditions which appear in this warranty is essential, as well as the submission of either a sales invoice or receipt. Failure to comply with said conditions may invalidate this warranty, taking into account the relevance of the equipment's aim and conditions and working limits. The distributor guarantees that the installed equipment is appropriate for the improvement of the quality of the water to be treated, in accordance with the equipment's characteristics and current legislation. The installation personnel and/or distributor guarantees the correct installation and initial operation of the equipment in accordance with the manufacturer's instructions and any current legislation, and will be responsible for any lack of conformity which arises from any incorrect application, installation or initial operation of said equipment. For any warranty claim the submission of the sales receipt is required. The 2-year period is calculated from the date the equipment is purchased from the distributor. If during the warranty period the equipment encounters any issues please contact your local distributor.

In the event of equipment installation, where the water to be treated has a hardness in excess of 25°F, IF/PEU/PAM shall not be held responsible for any equipment breakdown, poor working order or any associated consequences caused by the water's characteristics.

*** IF/PEU/PAM = IONFILTER/PURICOM EUROPE/
PURICOM AMÉRICA**

The equipment has been installed and is working in a satisfactory manner for the client and for the record:

*RO equipment prior treatment:

*RO equipment entry hardness [°F]:

*RO equipment entry TDS [ppm]:

*RO equipment entry pressure [bar]:

*TDS produced water (tap) [ppm]:

*Installation and initial operation service result sheet

CORRECT.

OTHER IN

The equipment's owners have been suitably and clearly informed of the use and maintenance required to ensure its correct working and of the quality of water to be produced. To these effects a maintenance contract is offered.

*Ref. Maintenance contract

The maintenance contract IS ACCEPTED.

The maintenance contract is NOT ACCEPTED.

In the event of needing further information, to report a breakdown or fault, please request either maintenance or technical assistance. Please read the sections relating to troubleshooting in this manual and contact the distributor or retailer.

COMPANY AND/OR AUTHORISED INSTALLER:

(date and signature)



NOTES FOR THE COMPANY/AUTHORISED TECHNICIAN/INSTALLER:
Information marked with an (*) should be filled in by the installation technician.

S/O

P/N

S/N

TECHNICAL ASSISTANCE LINE



5. EQUIPMENT INSTALLATION AND INITIAL OPERATION REGISTRATION SHEET TECHNICIAN

! NOTES FOR TECHNICIAN/INSTALLER: Please read this manual carefully. In the event of any queries please contact your distributor's Technical Assistance Service (S.A.T.).
 Information marked with an (*) should be filled in by the installation technician and copied to the WARRANTY SHEET.
 This document should be retained by the installer/distributor as it may be requested by IF/PEU/PAM*, with the aim of improving customer and after sales service. The technician who carries out the installation should be suitably qualified.

S/O

P/N

S/N

INFORMATION REGARDING THE EQUIPMENT'S APPLICATION:

Source of water to be treated:

Public water supply network.

Other information: _____

*RO equipment prior treatment: _____

*RO equipment entry hardness [°f] _____

*RO equipment entry TDS [ppm]: _____

*RO equipment entry pressure [bar]: _____

RO equipment entry chlorine concentration [ppm] _____

INSTALLATION PROCESS CONTROL:

Carbon pre-filter cleaning.

Carbon post-filter cleaning.

Membrane assembly.

Sanitation in accordance with protocol.

Flow restrictor check.

Maximum pressure calibration.

Review and fittings.

Pressurized system water tightness check.

*TDS produced water (Work surface tap) [ppf] _____

Clearly inform of the correct use and maintenance required to ensure correct working of the equipment and for the quality of the water produced. Given the importance that correct equipment maintenance has to ensure the quality of water to be produced, the owner of the equipment should be offered a maintenance contract by suitably qualified technicians.

COMMENTS

*Installation and initial operation results:

CORRECT (equipment installed and working properly. Produced water is suitable for this application)

OTHER COMMENTS: _____

TECHNICIAN IDENTIFICATION

Company and/or installer, date and signature:

CONFORMITY OF EQUIPMENT OWNER:

I have been clearly informed regarding the correct use and maintenance required for the installed equipment, and have been offered a maintenance contract as well as being informed of how to contact the Customer Service Department in the event of wishing to make any information requests, to report an equipment breakdown or malfunction, or to request any technical services.

Comments _____

*Ref. Maintenance contract: _____

The maintenance contract IS ACCEPTED.

The maintenance contract is NOT ACCEPTED.

Model / Ref.: _____

Owner, Mr/Mrs/Ms: _____

Street: _____

Telephone No: _____

Town/City: _____

State/County: _____ Post Code: _____

Date and signature:

Data Sheet



6. EQUIPMENT INSTALLATION AND INITIAL OPERATION REGISTRATION SHEET TECHNICIAN

DATE	TYPE OF SERVICE	NAME, SIGNATURE AND STAMP OF AUTHORISED TECHNICIAN	
/ /	<input type="checkbox"/> INITIAL OPERATION	TECHNICIAN	<input type="checkbox"/> ORDINARY <input type="checkbox"/> EXTRAORDINARY <input type="checkbox"/> WARRANTY
/ /	<input type="checkbox"/> MAINTENANCE COMPLETE	STAMP	
/ /	<input type="checkbox"/> REPAIR		
/ /	<input type="checkbox"/> SANITATION		
/ /	<input type="checkbox"/> OTHERS		
/ /	<input type="checkbox"/> MAINTENANCE COMPLETE	TECHNICIAN	<input type="checkbox"/> ORDINARY <input type="checkbox"/> EXTRAORDINARY <input type="checkbox"/> WARRANTY
/ /	<input type="checkbox"/> REPAIR	STAMP	
/ /	<input type="checkbox"/> SANITATION		
/ /	<input type="checkbox"/> OTHERS		
/ /	<input type="checkbox"/> MAINTENANCE COMPLETE	TECHNICIAN	
/ /	<input type="checkbox"/> REPAIR	STAMP	
/ /	<input type="checkbox"/> SANITATION		
/ /	<input type="checkbox"/> OTHERS		
/ /	<input type="checkbox"/> MAINTENANCE COMPLETE	TECHNICIAN	<input type="checkbox"/> ORDINARY <input type="checkbox"/> EXTRAORDINARY <input type="checkbox"/> WARRANTY
/ /	<input type="checkbox"/> REPAIR	STAMP	
/ /	<input type="checkbox"/> SANITATION		
/ /	<input type="checkbox"/> OTHERS		
/ /	<input type="checkbox"/> MAINTENANCE COMPLETE	TECHNICIAN	
/ /	<input type="checkbox"/> REPAIR	STAMP	
/ /	<input type="checkbox"/> SANITATION		
/ /	<input type="checkbox"/> OTHERS		
/ /	<input type="checkbox"/> MAINTENANCE COMPLETE	TECHNICIAN	<input type="checkbox"/> ORDINARY <input type="checkbox"/> EXTRAORDINARY <input type="checkbox"/> WARRANTY
/ /	<input type="checkbox"/> REPAIR	STAMP	
/ /	<input type="checkbox"/> SANITATION		
/ /	<input type="checkbox"/> OTHERS		
/ /	<input type="checkbox"/> MAINTENANCE COMPLETE	TECHNICIAN	
/ /	<input type="checkbox"/> REPAIR	STAMP	
/ /	<input type="checkbox"/> SANITATION		
/ /	<input type="checkbox"/> OTHERS		
/ /	<input type="checkbox"/> MAINTENANCE COMPLETE	TECHNICIAN	<input type="checkbox"/> ORDINARY <input type="checkbox"/> EXTRAORDINARY <input type="checkbox"/> WARRANTY
/ /	<input type="checkbox"/> REPAIR	STAMP	
/ /	<input type="checkbox"/> SANITATION		
/ /	<input type="checkbox"/> OTHERS		

Data Sheet

7. SERVICE BOOK. USER

DATE	TYPE OF SERVICE	NAME, SIGNATURE AND STAMP OF AUTHORISED TECHNICIAN			
/ /	<input type="checkbox"/> INITIAL OPERATION	TECHNICIAN			
/ /	<input type="checkbox"/> MAINTENANCE COMPLETE	STAMP			
/ /	<input type="checkbox"/> REPAIR				
/ /	<input type="checkbox"/> SANITATION				
/ /	<input type="checkbox"/> OTHERS				
/ /	<input type="checkbox"/> MAINTENANCE COMPLETE			TECHNICIAN	
/ /	<input type="checkbox"/> REPAIR	STAMP			
/ /	<input type="checkbox"/> SANITATION				
/ /	<input type="checkbox"/> OTHERS				
/ /	<input type="checkbox"/> MAINTENANCE COMPLETE			TECHNICIAN	
/ /	<input type="checkbox"/> REPAIR			STAMP	
/ /	<input type="checkbox"/> SANITATION				
/ /	<input type="checkbox"/> OTHERS				
/ /	<input type="checkbox"/> MAINTENANCE COMPLETE	TECHNICIAN			
/ /	<input type="checkbox"/> REPAIR	STAMP			
/ /	<input type="checkbox"/> SANITATION				
/ /	<input type="checkbox"/> OTHERS				
/ /	<input type="checkbox"/> MAINTENANCE COMPLETE			TECHNICIAN	
/ /	<input type="checkbox"/> REPAIR			STAMP	
/ /	<input type="checkbox"/> SANITATION				
/ /	<input type="checkbox"/> OTHERS				
/ /	<input type="checkbox"/> MAINTENANCE COMPLETE	TECHNICIAN			
/ /	<input type="checkbox"/> REPAIR	STAMP			
/ /	<input type="checkbox"/> SANITATION				
/ /	<input type="checkbox"/> OTHERS				
/ /	<input type="checkbox"/> MAINTENANCE COMPLETE			TECHNICIAN	
/ /	<input type="checkbox"/> REPAIR			STAMP	
/ /	<input type="checkbox"/> SANITATION				
/ /	<input type="checkbox"/> OTHERS				

- ORDINARY
- EXTRAORDINARY
- WARRANTY

- ORDINARY
- EXTRAORDINARY
- WARRANTY

- ORDINARY
- EXTRAORDINARY
- WARRANTY

- ORDINARY
- EXTRAORDINARY
- WARRANTY

- ORDINARY
- EXTRAORDINARY
- WARRANTY

- ORDINARY
- EXTRAORDINARY
- WARRANTY

Data Sheet

Warning: The recommended maintenance intervals are defined in the corresponding section of the **Technical Manual**.

C500

RO COMERCIAL 500

MUROCOMERCIAL5002016